

Article number: 20938011

Description: E+G
Eccentric bushing GN 715.2-12

Measures

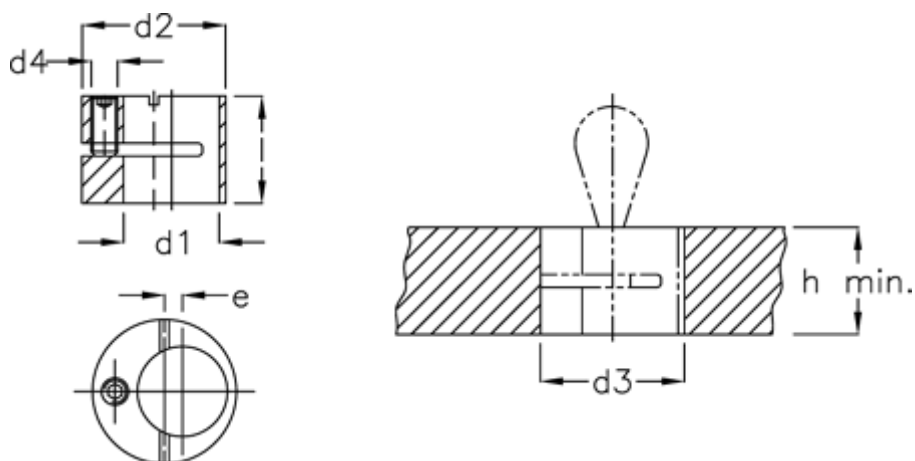

d1	= 12
d2	= 18
d3	= 18
d4	= M4
e	= 2
For spring plunger	= 8
H min	= 14
l	= 13.9